

BoscoLighting's HALO Downlight Series is an added luxury for your commercial or architectural projects. It features extra-deep cone reflector that designed to minimise glare and maximum visual comfort with an excellent light output.

It is perfect for most commercial applications or high-end residential and apartment interior spaces.

With the angled reflector, the lights will direct light to the wall or where an area needs to be highlighted. Alternatively, choosing the flat cone reflector, the product can create symmetrical light distribution.

Reflector options: flat cone reflector and angled reflector.

\*Please note: the 7W fitting is not adjustable, not available with angled reflector.

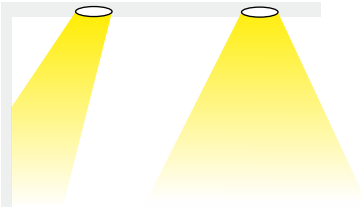

## Features

- Range from 7W to 40W
- Tilt angle: approx. 30° at a particular direction
- Easy installation
- LED Driver Included
- Supplied with Flex & Plug



## Downlight HALO



## Specs

Connect: AU Standard Flex & Plug

Dimming: Various dimming options available on request

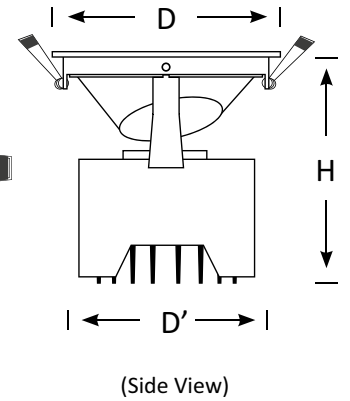
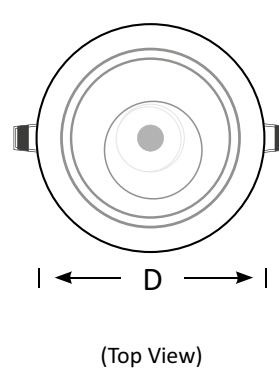
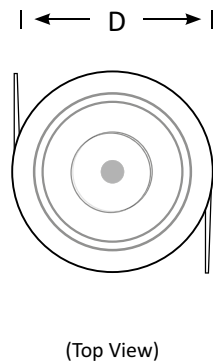
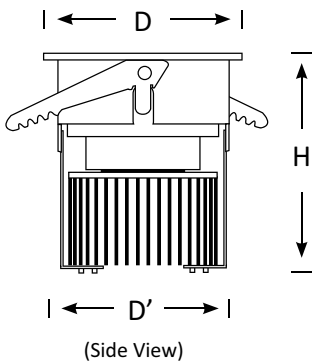

### BLDL-HALO-07

7W Recessed Downlight  
Luminous Flux (lm): 700  
CCT: Whites(3000K-6000K)  
Viewing Angle: 38°  
Dimensions (mm): D62\*H85  
Cutout(mm): D'50  
Weight(kg): 0.2



### BLDL-HALO-12

12W Recessed Downlight  
Luminous Flux (lm): 1200  
CCT: Whites(3000K-6000K)  
Viewing Angle: 38°  
Dimensions (mm): D86\*H115  
Cutout(mm): D'75  
Weight(kg): 0.4



### BLDL-HALO-20

20W Recessed Downlight  
Luminous Flux (lm): 2000  
CCT: Whites(3000K-6000K)  
Viewing Angle: 38°  
Dimensions (mm): D110\*H140  
Cutout(mm): D'100  
Weight(kg): 0.6



### BLDL-HALO-25

25W Recessed Downlight  
Luminous Flux (lm): 2500  
CCT: Whites(3000K-6000K)  
Viewing Angle: 24°/38°/60°  
Dimensions (mm): D140\*H155  
Cutout(mm): D'130  
Weight(kg): 0.8



### BLDL-HALO-30

30W Recessed Downlight  
Luminous Flux (lm): 2700  
CCT: Whites(3000K-6000K)  
Viewing Angle: 24°/38°/60°  
Dimensions (mm): D168\*H200  
Cutout(mm): D'155  
Weight(kg): 1.1



### BLDL-HALO-40

40W Recessed Downlight  
Luminous Flux (lm): 3600  
CCT: Whites(3000K-6000K)  
Viewing Angle: 24°/38°/60°  
Dimensions (mm): D198\*H210  
Cutout(mm): D'185  
Weight(kg): 1.3